

Alzheimer 19/79 Bed



Linear motor



Length



Max. width



Height



Num. of bed base sections



TR/ATR



Cardiac chair



CPR



SWL



MPL

Features

Thanks to its aesthetically-pleasing design, the optimisation of its movements and the solutions it provides, Pardo's Alzheimer bed is the perfect solution for use in care homes for the elderly, nursing homes and even at home.

The Alzheimer bed reduces the risk of falls and their consequences, which can be serious, thanks to the low height to which it can be lowered. This significantly increases safety at night, especially in active patients.

It also offers the possibility of incorporating guardrails for increased safety in tasks that require raising the bed and when the user has greater physical deterioration.

The Alzheimer bed can also adopt other therapeutic positions such as the Trend, Reverse Trend, cardiac chair and Fowler positions.

As it does not have a lower chassis, there is total freedom to introduce hoists to help lift and transfer the patient.

The lifting motors are programmed to lock the bed at different heights and make it easier for the patient to

sit up, lie down or be moved. These pre-programmed stops are also made to prevent the bed from being raised in the Trend or Reverse Trend positions, preventing risks for the patient.

The bed also has small diameter wheels (4 + 2) which favour this low minimum height position and moving the bed. It also has a sophisticated and effective braking system to prevent the bed from being moved accidentally.

Other features of the bed are:

- Control with cable.
- Wide variety of head boards and foot boards.
- Two holders on the bed's head board for accessories like support handles or drip support.



Alzheimer 19/79 Bed



Technical information

Total length with headboard and footboard (A)	2100 ± 5 mm.
Total width without rails (B)	1060 ± 5 mm.
Minimum / maximum rest surface height (without mattress) (C y C')	190 / 725 ± 5 mm.
First stop height	405 mm.
Second stop height	270 mm.
Recomended mattress dimensions	900 x 1900 x 140 mm.
Bed base section length (D / E / F / G)	840 / 170 / 320 / 475 mm.
Bed base width (H)	900 mm.
Casters diametre (4 + 2)	Ø75 (4) / Ø100 (2)
Backrest tilting angle (I)	55° ± 3°
Legrest tilting angle (J)	23° ± 3°
Footrest tilting angle (K / K')	13° / 10° ± 3°
Trendelemburg / Antitrendelemburg	15° / 15° ± 2°
Auto-return	87 ± 3 mm.
Maximum patient weight (MPW)	140 kg.
Safe working load (SWL)	230 kg.
Rails length	1365 mm.
Rails length from the bed base sections (without mattress)	500 ± 5 mm.

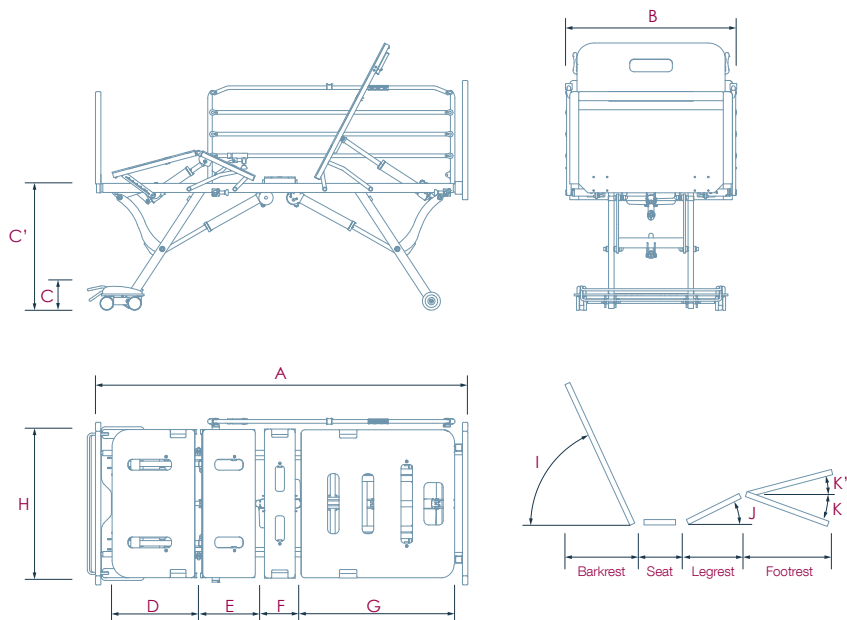

Electrical information

Lifting system	By linear motors
Backrest and legrest lifting system	By linear motors
Voltage and frequency	230 V
Electric shock protection / liquid penetration	Type B / IP66
Motor intermittent operation	10% 2 min. - 18 min

Standard

Controls

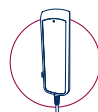

Patient control

Protection

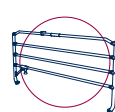

Tubing rails

Transport



Front casters
Ø100 mm.
(2 units)

Wellness



HPL base
bed sections

Others

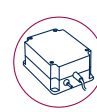

Battery

Accessories

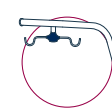

IV Pole



Trapeze bar

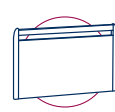

C5 wooden
footboard and
headboard



Back casters
Ø75 mm. (4
units)

Optional

Controls

Protection

Transport

Wellness

Others

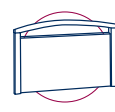

C2 wooden
footboard and
headboard